

Installation Instructions

Continuum™ Hygienic Wall Cladding

Important

Storage

Flat sheet - Store Continuum™ Rigid Sheet in a clean, dry, interior area at temperatures between 50° F and 95° F [10°-35°C]. Keep out of direct sunlight. Make sure sheet is well supported.

- Store in a clean, dry, interior area
- Avoid direct sunlight
- Store between 50°F and 95°F [10°-35°C]

Acclimate

24 hours before the installation, acclimate the sheet material and adhesive in the environmentally controlled area where it will be installed. The ideal conditions are, temperature between 60°F and 75°F [16°-24°C] and a humidity level is between 35-55%. Maintain a constant temperature between 65°F - 80°F [18°-27°C] and a constant humidity level less than 80% in the installation area 24 hours before installation, during the entire installation and 48 hours after the installation.

- Acclimate sheet and adhesives in the environmentally controlled installation area.
- Acclimate sheet and adhesives at temperatures between 65°F and 80°F [18°-27°C].
- Acclimate sheet and adhesives at humidity less than 80%.
- Maintain a constant temperature and humidity 24 hours before, during and 48 hours after installation.

Recommended Adhesives and Substrates

547-SSA Dry Wall Adhesive: **New Drywall, Untreated Plywood, Cement Board****

548 Non-Porous Surface Adhesive: New & Painted Drywall, Mold/Moisture Resistant Faced Drywall, Treated & Untreated Plywood, Cement Board, Aluminum, Stainless Steel, Galvanized Metal, FRP, Ceramic Tile, Polyurethane or Polystyrene foam, Foil Faced Insulation.

** adhesive may take longer to cure and will require bracing to ensure complete bonding

Inpro Bond Roll-On Adhesive: **Smooth Walls (levels 4 Drywall Finish)**

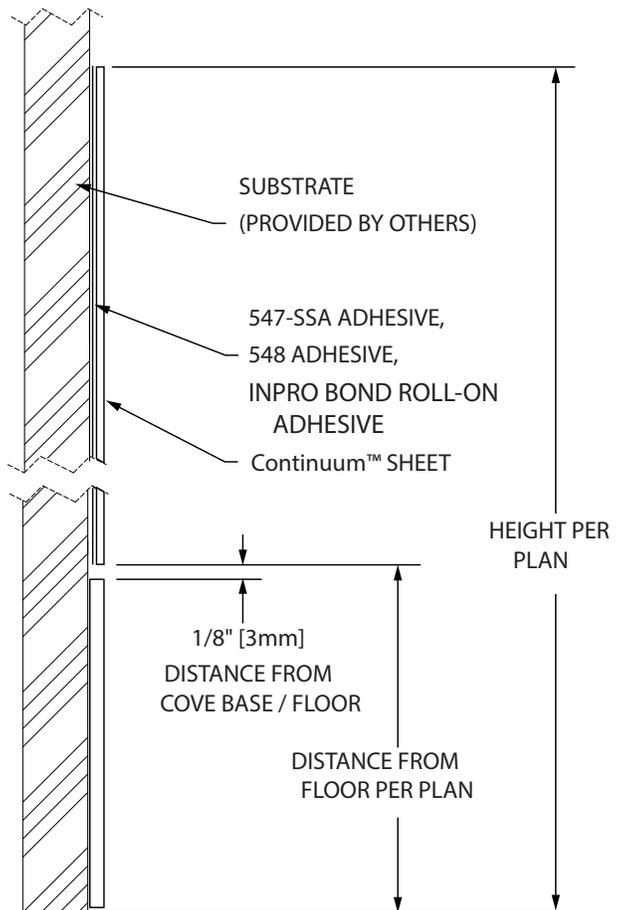

Recommended Tools

- Extension Roller
- V-notched Trowel
- Circular Saw with Fine Toothed Carbide Blade
- Oscillating Multi-tool with Wood Blade
- Jigsaw
- Swivel Head 18 Gauge Shears
- Drywall Rotozip
- Utility Knife and Blades
- Deburring Tool
- Saw Horses
- Plywood boards (larger than panels)
- Dry, Lint Free Rags
- Sandpaper
- Blue Painters Tape
- Solvent / Water and Soap for clean up.
- Denatured Alcohol
- 1/4" Nap Paint Roller (Inpro Bond Roll-On)
- 9" Paint Roller Frame
- Telescoping Extension Rod

IPC.3220/REV.4

IPC® Door + Wall Protection

inpro.com • 800.222.5556 • 262.679.9010

World Headquarters S80 W18766 Apollo Drive, Muskego, WI 53150 USA

Installation Hotline: 866.394.6776

inpro®

Installation Instructions

Continuum™ Hygienic Wall Cladding



INPRO# 617
TOP CAP



INPRO#618
VERTICAL
DIVIDER

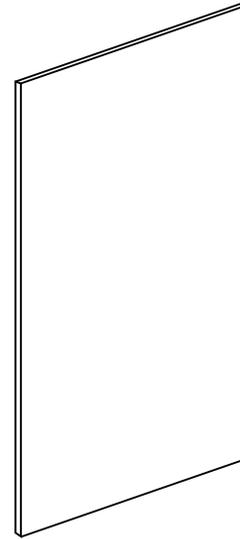

Continuum™
SHEET



INPRO#620
OUTSIDE
CORNER

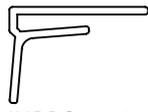

INPRO#619
INSIDE
CORNER



INPRO #546
TROWEL

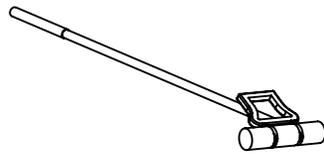

INPRO #333
EXTENSION ROLLER

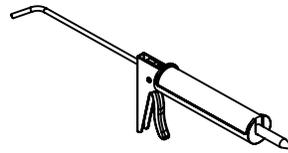

COLOR MATCH CAULK
(OPTIONAL)



ADHESIVE
DRYWALL ADHESIVE
INPRO# 547-SSA

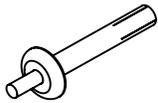

INPRO # SSNAIL-xxxx
DRIVE PINS

NON-POROUS SURFACE
ADHESIVE
INPRO# 548

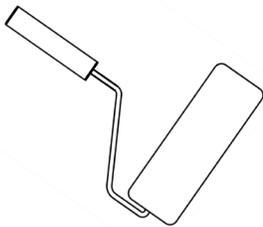

INPRO#335,
9" ROLLER FRAME

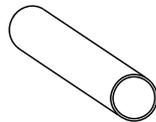

INPRO#334, 1/4" NAP
ROLLER COVER -
9-INCH

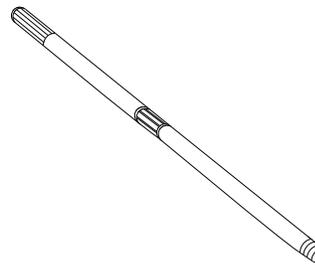

INPRO#336,
TELESCOPING
EXTENSION ROD, 4'-8'

FOR SMOOTH WALLS
INPRO BOND ROLL-ON,
INPRO#602: 1-GAL,
INPRO#603: 4-GAL

IPC® Door + Wall Protection

inpro.com • 800.222.5556 • 262.679.9010

World Headquarters S80 W18766 Apollo Drive, Muskego, WI 53150 USA

Installation Hotline: 866.394.6776

inpro®

Installation Instructions

Continuum™ Hygienic Wall Cladding

Wall Preparation

Walls must be free from dirt, grease and loose paint. Remove any coatings designed to improve clean-up since these coatings may affect adhesion. Glossy surfaces may require sanding or priming to help promote adhesion. Do not install sheet if the moisture content of the drywall is greater than 4%. Ensure walls are flat and surface finish is even.

New drywall or plaster – New drywall should have a level 3 dry wall finish (Taped joints with 2 coats of joint compound). Before install walls must be smooth and wiped clean to remove dust. DO NOT seal or prime walls with paint or primer. Any clearly uneven areas should be filled and smoothed. Tapered joints need only a fill and tape coating using a setting joint compound. Note: Inpro Roll-On Adhesive is for smooth wall (level 4 drywall finish)

- Remove Dust and Dirt
- DO NOT Seal walls with paint/primer.
- Inpro Roll-On Adhesive is for smooth wall (level 4 drywall finish)

Painted Drywall or Plaster - Painted surfaces will prevent solvent-free or solvent based adhesives from drying. Any painted surfaces must be roughed up using a wall paper remover, or low grit (20 or less) heavy duty sandpaper to break the moisture barrier of the paint.

- Paint prevents adhesive from drying and achieving bond.
- Strip the paint off wall, at a minimum rough painted surface to remove moisture barrier.

Plywood - Plywood walls must be flat and even. Any warped plywood must be removed and replaced. Solvent-Free adhesives (i.e. 547-SSA) cannot be used on any pressure treated, or fire-rated plywood.

- Ensure installed wall is flat and even
- Remove and Replace any warped plywood

Concrete and Concrete Masonry Units – Panels installed onto concrete block or brick walls will likely result in loose spots or bulges. It is recommended to install gypsum board, or another appropriate substrate over the furring, then install Continuum™ panels according to the standard installation instructions. If it is the preference of the owner or contractor to install over existing concrete or block, panels should be installed with 548 Adhesive.

- Install appropriate substrate (i.e. Gypsum or plywood)
- Follow instructions for installed substrate
- If you must install on block walls use Advanced Polymer Adhesives

Non-Porous Substrates - Non-porous substrates include metal, ceramic tile, high-pressure laminate, epoxy painted walls, vinyl wall covering (VWC) and rigid sheet. Solvent, polymer-based, and latex-based adhesives will not dry on non-porous surfaces. Adhering Continuum™ sheet over existing sheet or VWC will increase smoke generation and flame spread and negate the Class A fire rating. If you choose to do this contact adhesive manufacturer for additional recommendations.

Installation Instructions

Continuum™ Hygienic Wall Cladding

Install Preparation

Environmental Concerns

Spaces with High Humidity / Low Temperatures

When installing Continuum™ in spaces that contain high humidity or low operating temperatures, it is critical to always acclimate the panel to the operating conditions of that space before installing panels. In these cases, it is critical to follow the installation guide for expansion/contraction spacing. Be sure to select an adhesive which is capable of bonding in the conditions required. In rooms with high humidity, failure to fully seal moisture entry points with silicone can likely result in curling, warping, and delamination.

Spaces Near Heat Sources

Continuum™ should not be used near heat sources which radiates heat over 130 °F (55°C) (such as cooking appliances, space heaters, etc...) . In these conditions Inpro Stainless Steel Wall Panels are recommended.

Pre-Installation: Cutting and Dry Fitting Sheets

Before applying adhesive or fastening, dry fit each panel to its final location. Any cutting, drilling, or modification to the panel should be done before application of adhesive. When laying out sheet allow a 1/8" [3mm] gap between sheet material and ceilings, floors, corners, door casings, window casings and between sheets.

Cut sheet material with a metal straight edge and circular saw. Always cut so the blade enters the back (un-textured side) of the sheet. If using a utility knife, cut the sheet using multiple passes.

Cut openings in the sheet for outlets and other objects located on the wall. Inpro recommends the use of an Oscillating Multi-Tool for cutting out openings. Openings can also be cut by drilling a 1/4" (6mm) diameter hole inside of the area to be removed, then use a jig saw or swivel headed shears to cut out the section to be removed. If mechanically fastening through the sheet to mount fixtures, pre-drill holes using a drill bit that is 1/4" (6mm) larger than the fastener (required thru sheet only).

- Mark plumb lines and level lines on wall.
- Allow 1/8" [3mm] between sheet and ceilings, floors, walls, casings and other sheets.
- Do NOT install cove base directly over rigid sheet;
- Use a straight edge and fine toothed circular saw to cut sheet material.
- Cut sheet using multiple passes when using a utility knife.
- Precut outlet and fixture locations
- DO NOT install sheet too close to heat sources.
- Dry fit the sheet to the wall before install

Installation Instructions

Continuum™ Hygienic Wall Cladding

Install and Adhesive Application

547-SSA Dry Wall Adhesive Application

547-SSA adhesive must be applied to the back of the sheet in a cross hatch pattern before installation using a V-notch trowel. Notches must be 3/16" wide X 1/4" deep and spaced 1/2" apart (center to center). Adhesive is ready to adhere as soon as its applied to back of panel.

Application temperature: After following the steps to acclimate the materials, maintain a constant temperature between 65°F and 80°F [18°-27°C] with an indoor humidity level below 80%.

Apply adhesive to the entire back face of the sheet. Remove any unwanted excess adhesive from surfaces with a damp cloth before the adhesive has cured. Cured adhesive is difficult to remove. Do not let adhesive dry in the notches of the trowel. This will change the application rate of the trowel.

- Allow materials to acclimate following the recommendations stated earlier.
- Apply 547-SSA using a V-notch trowel with 3/16"x1/4" spaced 1/2" [13mm] apart. (InPro item #546)
- Apply adhesive only on back of sheet
- Apply adhesive to the entire back side of sheet
- Remove any excess adhesive before it has cured
- Clean trowel so notches do not get clogged
- If adhesive dries, tools and adhesive may be cleaned with water/acetone/vinegar mixture
- Application rate is approximately 50 square feet per gallon [1.22 sq. M/per liter] using specified V-notch trowel

Figure 1

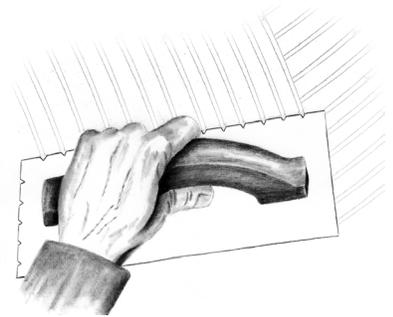

548 Non-Porous Surface Adhesive Application

548 Adhesive must be applied to the back of the sheet in a cross hatch pattern before installation using a V-notch trowel. Notches must be 3/16" wide X 1/4" deep and spaced 1/2" apart (center to center). Adhesive is ready to adhere as soon as its applied to back of panel.

Application temperature: After following the steps to acclimate the materials, maintain a constant temperature between 65°F and 80°F [18°-27°C] with an indoor humidity level below 80%.

Apply adhesive to the entire back face of the sheet. Working time of the adhesive is 20 minutes, apply as much adhesive within that 20 minute window as allowable on for the panels. Remove any excess adhesive from unwanted surfaces with a damp cloth before the adhesive has cured. Cured adhesive is nearly impossible to remove. Do not let adhesive dry in the notches of the trowel. This will change the application rate of the trowel.

- Allow materials to acclimate following the recommendations stated earlier.
- Apply 548 Adhesive using a V-notch trowel with 3/16"x1/4" spaces 1/2" [13mm] apart. (InPro item #546)
- Apply adhesive only on back of sheet only
- Apply adhesive to the entire back side of sheet.
- Working time of adhesive is roughly 20 minutes @ 70 [21°C]
- Remove any excess adhesive before it has cured.
- Clean trowel so notches do not get clogged.
- After installation of panel, clean any adhesive on the exposed face of the panel within 10 minutes using denatured alcohol and a clean rag.
- Application rate is approximately 50 square feet per gallon [1.22 sq. M/per liter] using specified V-notch trowel

Installation Instructions

Continuum™ Hygienic Wall Cladding

Figure 2a

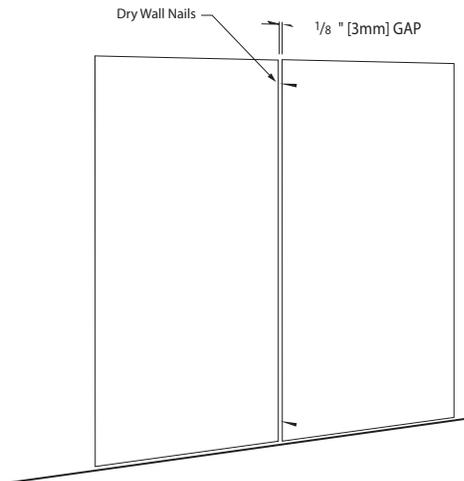
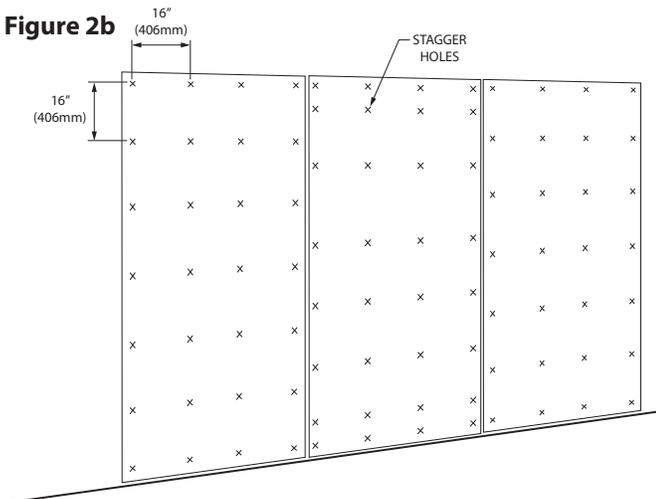

Figure 2b



Adhesive Curing

Temperature and humidity levels will affect the time it takes for adhesive to cure. Under normal conditions working time should be 20 minutes at 70 °F. Working time decreases with increases in temperature. **The installer is responsible for determining the cure time of the adhesive, based on job site conditions. Do a test installation if needed.**

- Adjust cure time for temperature and humidity level.
- Working of adhesive is 20 minutes.
- **The installer is responsible for determining the cure time of the adhesive, based on job site conditions.**
- Do a test installation, if needed.

Positioning Sheet

As soon as adhesive has been evenly applied to back of sheet, position the sheet on the wall aligning the edges with plumb lines or level lines. Hold sheets back from ceiling, floors, corners, casings and other sheets by 1/8" [3mm] to allow for expansion (see figure 2a). If needed reposition the sheet on the wall by carefully pulling it back and re-aligning it to the wall. Use an extension roller (InPro item # 333) to firmly embed the sheet into the adhesive. Apply heavy body pressure to every square inch of sheet, starting at the center and working to the edges, making sure it is bonded securely to the wall.

- Ensure adhesive is evenly spread on back of sheet.
- Position sheet on wall
- Allow 1/8" [3mm] gaps for expansion.
- Reposition sheet before rolling if needed.
- Roll entire sheet with extension roller, starting at the center and working to the edges.

Nylon Drive Rivet Installation

If using rivets or fasteners to secure sheets to wall, fasteners should be located 16" on center both horizontally, and vertically. Fasteners should be kept 1" (25mm) - 1-1/2" (35mm) from each edge (see figure 2b). Panels should be pre-drilled at each fastener location using a drill bit that is 1/8" - 1/4" larger than the fastener. Apply adhesive after drilling holes. Always stagger hole locations on following sheets as shown.

Holes in the wall substrate should be drilled only slightly larger than the rivet fastener. Before inserting rivets, apply silicone to pre-drilled hole on sheet.

Installation Instructions

Continuum™ Hygienic Wall Cladding

Trim Pieces (see figures below)

If using trim, begin installation from an inside or outside corner, working outward. If using divider bars, precut to length before installing. Cut trim pieces with a metal straight edge and sharp utility knife. If required, run a small bead of clear silicone sealant into the channel on each trim piece, before installing.

Install the first sheet on the wall and be sure to leave 1/8" (3mm) gap between sheet and corner. Slide vertical divider bars or inside corners behind the sheet. Overlap the edge of the sheet on the wall with the divider bar or inside corner, be sure to maintain a gap within the trim piece to allow for expansion and contraction. When using top caps and vertical divider bars, notch the back of the divider bar where it intersects with the top cap (see figures below). Install the top cap by sliding it on the top edge of the sheet after the sheet is in place. Roll all trim pieces and the entire sheet with an extension roller (InPro item # 333).

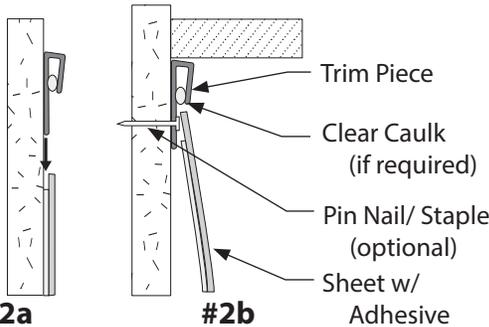

#2a

**Top Cap
Wainscot Height**
1. Install sheet
2. Slide top cap
trim behind sheet

#2b

**Top Cap
Fixed Height**
1. Install trim against
fixed corner.
(pin nail trim if desired)
2. Install sheet into trim.

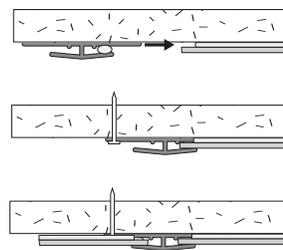

#3

Divider Bars
1. Install 1st Sheet
2. Slide divider bar behind
previously installed sheet
3. Install 2nd sheet, slide
sheet up to locator nub

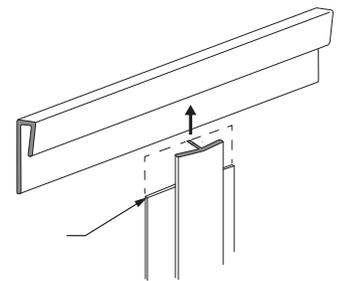

Intersecting Vertical Trims

1. Cut vertical trim to length.
2. Clip the side wings of divider bar so
"T" butts against edge of top cap.
3. Slide vertical trim behind previously
installed sheet

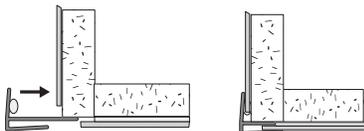

#1

Outside Corners

1. Install last sheet on oppsing wall, leaving a 1/8" [3mm] gap
2. Install 2nd sheet run, on last sheet ensure a 1/8" [3mm] gap is
left between substrate corner and edge of sheet
3. Attach outside corner trim over previously installed sheet as
shown (Clear Caulk or similar adhesive is recommended)

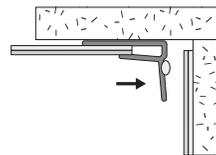

#4

Inside Corners

1. Install first sheet on opposing wall, leaving a
1/8" [3mm] gap, continue run.
2. Install the 1st sheet of the adjacent run with
inside corner trim attached shown (clear caulk or
similar adhesive is recommended) to bond corner
3. Apply painers tape to free corner.

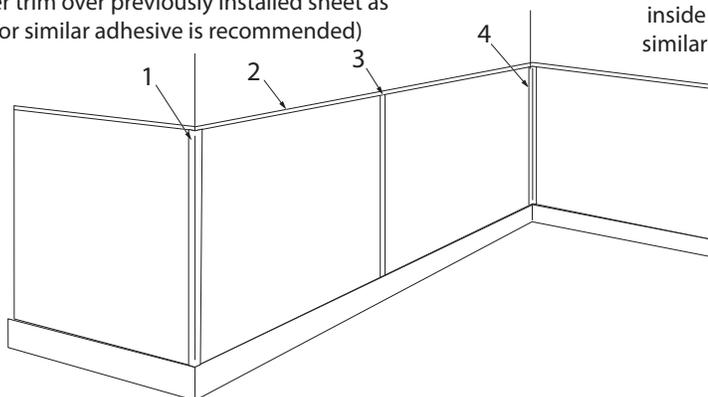

IPC® Door + Wall Protection

inpro.com • 800.222.5556 • 262.679.9010

World Headquarters S80 W18766 Apollo Drive, Muskego, WI 53150 USA

Installation Hotline: 866.394.6776

inpro®

Installation Instructions

Continuum™ Hygienic Wall Cladding

Inpro Bond Roll-on Adhesive

Adhesive Application Inpro Roll-On

Application temperature: After following the steps to acclimate the materials, choose and maintain a constant temperature between 65°F and 80°F with an indoor humidity level below 80%. Use a ¼" nap paint roller cover to apply adhesive. The adhesive is a light blue color. Apply adhesive evenly to the entire area where the sheet is to be installed. Apply adhesive only to the wall surface. Do not apply adhesive to the back of the sheet. Remove any excess adhesive from unwanted surfaces with a damp cloth before the adhesive has cured. Cured adhesive is nearly impossible to remove. De-natured alcohol and a soft cloth may help remove cured adhesive. Adhesive application rate is 250 square feet per gallon with a ¼" nap roller.

Note: Inpro Bond Roll-On Adhesive is for smooth walls (level 4 drywall finish)

- Note: Inpro Bond Roll-On Adhesive is for smooth walls (level 4 drywall finish)
- Inpro Bond Roll-on Adhesive - Seal substrate with a good quality paint or primer.
- Allow materials to acclimate
- Adhesive is light blue to help you see if the application is even
- Use a ¼" nap paint roll cover to apply adhesive to the wall. Do not apply to back of the sheet
- Remove adhesive from unwanted surfaces before it cures
- Remove cured adhesive with denatured alcohol or rubbing alcohol
- Application rate is approximately 250 square feet per gallon
- Apply Inpro Bond Roll-On Adhesive only to the wall.

Porous Substrate – Roll-on Adhesive tack time

Temperature and humidity levels will affect the time it takes for adhesive to tack-up. After adhesive is applied to the wall, install sheet within 15-minutes using slight initial hand pressure. Prior to rolling the sheet you will be able to reposition the sheet. As time passes repositioning sheet will be more difficult and possibly damage the drywall. As it cures, adhesive becomes tacky and does not transfer to your finger – at this point you will not be able to apply the sheet and reposition the sheet. If too much time has passed and you think you will need to reposition the sheet, apply another coat of adhesive to the wall and install the sheet immediately. The installer is responsible for determining the tack time of the adhesive, based on job site conditions. Do a test installation if needed.

- Temperature and humidity levels affect adhesive tack times.
- After adhesive is evenly applied to the wall install sheet within 15-minutes
- If needed reposition sheet before rolling it to the wall.
- When too much time has passed (tack time longer than 15-minutes) repositioning may not be possible
- If you think you will need to reposition the sheet, apply another coat of adhesive to the wall and install the sheet immediately
- The installer is responsible for determining the tack time based on job-site condition. Test if needed.

Non-Porous Substrates – Roll-on Adhesive tack time

Some non-porous substrates include metal, high-pressure laminate, epoxy painted walls, and vinyl wall covering. When applying adhesives to these substrates, moisture in the adhesive will not be absorbed by the substrate. Longer tack times are required. Roll adhesive onto the substrate and allow adhesive to tack-up for 45-minutes. Let the adhesive become tacky and not transfer to your finger when touched. Air movement can reduce tack time. Temperature and humidity levels will affect the time it takes for adhesive to tack-up. The installer is responsible for determining the tack time of the adhesive, based on job site conditions. Do a test installation if needed. Align the sheet perfectly since the longer tack time makes repositioning the sheet difficult or impossible.

- Non-porous substrates require longer tack times
- Allow adhesive to tack-up so the adhesive does not transfer to your finger (about 40-50 minutes)
- Installer is responsible for determining tack times. Test if needed.
- Position sheet perfectly, repositioning will not be possible.

Installation Instructions

Continuum™ Hygienic Wall Cladding

Inpro Bond Roll-on Adhesive (continued)

Positioning the sheet

Wipe the back of the sheet to remove any dust. Position the sheet on the wall aligning the edges with plumb lines or level lines. Hold sheets back from ceiling, floors, corners, casings and other sheets by 1/8" to allow for expansion. Apply slight hand pressure to the surface of the sheet. With porous substrates, if needed, reposition the sheet on the wall by carefully pulling it back and re-aligning it to the wall. Use an extension roller (Inpro item # 333) to firmly bond the sheet to the adhesive. If using top caps (J-trim) do not roll a 1-inch area where the top caps are to be installed. Apply heavy body pressure to every square inch of sheet, starting at the center and working to the edges, making sure it is bonded securely to the wall. Once rolled, the sheet cannot be re-positioned without damaging the drywall.

- With very little pressure, position sheet on the wall aligning with level lines.
- Leave a 1/8" gap between sheets, casings, base board and ceilings
- Before rolling the sheet, reposition the sheet by carefully pulling it back from the wall.
- Once properly positioned, roll sheet with extension roller to make sure it is bonded to the wall.
- If using top caps do not roll the area where they are to be installed.

Trim Pieces

If using trim pieces, install the first sheet on the wall. Cut trim pieces with a metal straight edge and sharp utility knife. Slide vertical divider bars or inside corners on the next sheet to be installed. Overlap the edge of the sheet on the wall with the divider bar or inside corner. When using top caps and vertical divider bars, notch the back of the top cap where it intersects with the divider bar. Install the top cap by sliding it on the top edge of the sheet after the sheet is in place. Roll all trim pieces and the entire sheet with an extension roller (InPro item # 333).

- Cut trim pieces with a sharp utility knife.
- Overlap trim piece over the first sheet installed.
- Notch the back of the top cap where it intersects the vertical divider bar.
- Slide top cap on edge of sheet after sheet is on wall.
- Roll all trim pieces and entire sheet with extension roller.

Clean-up

Completion: Immediately upon completion of installation, clean sheet and remove layout marks excess adhesive and surface blemishes. Cured adhesive is difficult to remove. Use denatured alcohol and rub gently with a soft cloth. After adhesive is removed, wipe the area with a general-purpose cleaner like fantastic®. Rinse the area with a water dampened cloth. Dry with a clean, soft cloth.

Maintain environmentally controlled conditions after the installation. Large temperature changes can cause delamination.

Installation Instructions

Continuum™ Hygienic Wall Cladding

Color Matched Caulk

Install all sheets needed for the space leaving a 1/8" [3mm] gap between each sheet using dry wall nails or similar. Apply blue painters tape along the edge of each sheet after cleaning and rolling each sheet. Allow adhesive to cure for a minimum of 6 hours.

Use Color Matched Caulk to fill in the joints between sheets. Cut the spout on the tube at a 45° angle. Apply the color matched caulk to the joint filling the void completely. With a putty knife, remove excess caulk from the joint. Immediately after applying the caulk remove the painters tape. Remove unwanted caulk, before it cures, with a water dampened cloth.

- While adhesive cures maintain sheet spacing using two drywall nails.
- Apply masking tape on the edges of the joint.
- Apply caulk to joint and remove excess with putty knife.
- Remove painters tape before caulk cures.
- Repeat caulk application if sinking occurs.
- Remove unwanted caulk before it cures.

Clean-up

Completion: Immediately upon completion of installation, clean sheet and remove layout marks, excess adhesive, and surface blemishes. Cured adhesive is difficult to remove. Use denatured alcohol and rub gently with a soft cloth. After adhesive is removed, wipe the area with a general purpose cleaner like fantastik®. Rinse the area with a water dampened cloth. Dry with a clean soft cloth.

- Upon completion, remove layout marks, excess adhesive and surface blemishes.
- Cured adhesive.
- Use denatured alcohol and gently rub.
- Follow by wiping with a cleaner like fantastik®.
- Rinse sheet with water dampened cloth.

Maintenance

For general cleaning, use Antibacterial fantastik® All Purpose Cleaner Heavy Duty. Use a clean, lint-free cloth and wipe clean. For tough stains, like markers, pencil, white marks, and rubber heel marks, the following was shown to be most effective: Do not use any abrasive cleaning cloths or sponges.

- Zep® Heavy Duty Citrus Degreaser
- Clorox® Clean-up with Bleach
- Antibacterial fantastik® All Purpose Cleaner Heavy Duty

1. Spray products onto sheet and wipe with a dampened cloth.
2. Repeat process if stain remains. If cleaning product residue remains, rinse with water.

Note: Any reference to a specific branded product does not constitute an endorsement by InPro Corporation.

If pressure/power washing sheets, maintain a 3ft. [1m] distance from sheet, trim pieces, and seams. Ensure pressure does not exceed 3,300 psi. DO NOT use direct, focused pressure streams over sealant joints.

After Installation

Maintain environmentally controlled conditions after the installation. Large temperature changes can cause delamination.

- Maintain environmentally controlled conditions.
- Large temperature changes can cause delamination.

Continuum™ Supplemental Information

Continuum™ Hygienic Wall Cladding

Important Notes

1. Store all materials in an indoor location that is clean, dry and away from direct sunlight. Temperature is to be between 50°F and 95°F.
2. Maintain a climate controlled installation area.
3. When installing, choose and maintain a temperature between 65°F-80°F and a humidity level below 80%, 24 hours before and during installation
4. Maintain temperatures between 65°F and 80°F for 48 hours after installation.
5. Do not install sheet if the moisture content of the drywall is greater than 4%.
6. Acclimate sheet, trim and adhesives to the installation temperature 24 hours before installation.
7. With large orders of sheet, acclimate the sheet in stacks of 25.
8. Do not expose sheet material to ultraviolet light. Exposure to UV may result in fading or color change.
9. Do not install sheet material in direct sunlight or areas of elevated temperature. Excessive heat may cause bubbles and/or distorted sheet.
10. Cut sheet material with a metal straight edge and a circular saw. If using a utility knife multiple cuts may be required.
11. Maximum installed sheet length is 10-feet.
12. Leave a 1/8" [3mm] gap between sheets for expansion and contraction and around doorjamb, baseboards and ceiling. Use sealants or trims as recommended by Inpro.
13. Leave oversized openings in the sheet for pipes, ducts, etc. to allow for expansion. Use sealant as n
14. Use pick resistant Fastfill™ Color Matched Caulk. Do not use pick proof sealants. These do not allow for thermal movement.
15. Verify cove base installation with the cove base or the cove base adhesive manufacturer to see if it can be installed over a non-porous surface.

Continuum™ Supplemental Information

Continuum™ Hygienic Wall Cladding

16. 547-SSA Dry Wall Adhesive, 548 Non-Porous Surface Adhesive and Inpro Bond Roll-On Adhesive are the recommended adhesives. Use of other adhesives will void the fire rating and warranty.
17. Inpro Bond Roll-On Adhesive is for smooth walls (level 4 drywall finish).
18. Make sure the back of the rigid sheet is free from dust and dirt. Remove dust with a clean cloth and clean water. Do not use any cleaners or solvents.
19. Do not use adhesives that have been frozen and thawed more than 5 times. Frozen adhesives must completely thaw and must be at the installation temperature 24 hours before using.
20. Do not stir or dilute adhesives.
21. Apply 547-SSA Dry Wall Adhesive, 548 Non-Porous Surface Adhesive with the proper trowel only to the wall surface.
22. Remove excess adhesive, before it cures, with clean warm water and a soft cloth.
23. Do not use harsh solvents on sheet material. Do not use abrasive pads or cloths on sheet material.