

Straight Grab Bar - 16"

Technical Data

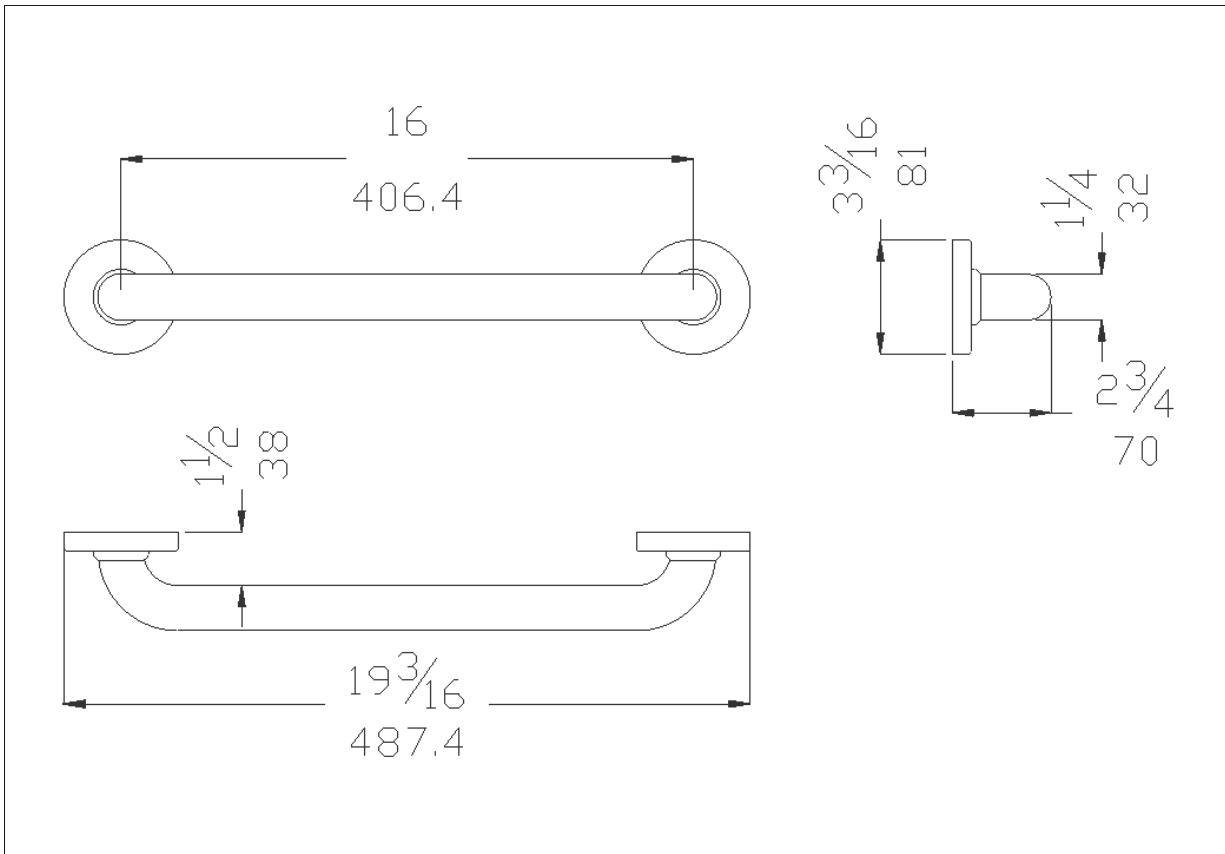

Straight Safety Support

Code **DSGBVST16** Series **Vinyl Coated Grab Bars**

Net weight lb. Dimensions [WxDxH] In. 19 3/16x2 3/4x3 3/16

In use weight capacity Vertical lb. 449,74

Use and installation info

Use

Cleaning

Fasteners

Packaging information

Type of package

Dimensions [WxDxH] In. Weight lb.

Available colours

WHT - WHITE

IVRY - IVORY



06/17/2020