

Prism™ Solid Surface Privacy Partitions

Measuring Guide

Prism™ Solid Surface Privacy Partitions How-To Measuring Guide

A Step-By-Step Guide
to Measuring Toilet Partitions

IPC.1327/REV.4

Prism™ Solid Surface Privacy Partitions

Measuring Guide

Standards for Measuring:

- Partition widths are measured building sidewall to sidewall, sidewall to centerline of first panel, and centerline of first panel to centerline of second panel, and so forth.
- Partition depths are measured from the building backwall to centerline of the pilaster or door.
- Door opening size is measured from pilaster edge to pilaster edge.
- All partition parts are 1" thick.
- Door and wall panel height is a standard 58".
- Door and wall panel clearance height from the floor is 12" standard.
- Wall-hung screens, or urinal dividers are 42" high and 24" wide max.

Standards Depth:

- Standard depth for partitions with inswing doors is 60" from the back wall to centerline of the pilaster. For smaller spaces, minimum depth is to use 30" (distance from back wall to front of toilet), plus the door opening size (typically 24"), for example 30" + 24" = 54" minimum. For ADA-wheelchair accessible partitions, see below*.

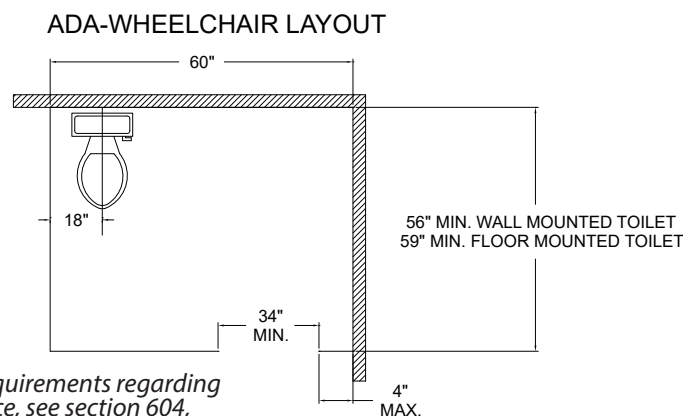

For detailed requirements regarding ADA compliance, see section 604, Water Closets & Toilet Compartments, in the U.S. Department of Justice, 2010 ADA Standards

Wall-to-Wall Measurements:

- When toilet partitions are recessed between two building walls, the critical measurement is the smallest space between the walls.
- Measure wall-to-wall dimensions along the centerline of pilasters and doors, or front of the partition.
- If there is existing baseboard, or tile cove base, measure the smallest distance, and note on the drawing that gaps between the pilaster and wall be kept to a minimum.

Room conditions, such as cove moldings, tiled walls, windows and baseboard heaters, may affect measurements. Be sure to note special conditions on your drawing.

Prism™ Solid Surface Privacy Partitions

Measuring Guide

Corner Layout

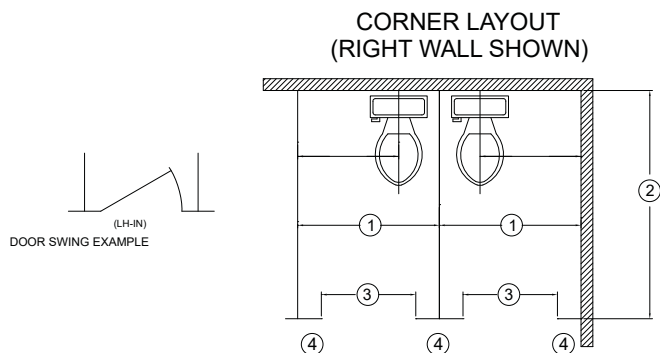

First Step:

Simple drawings are often the best way to provide information to InPro. Follow these simple steps to determine your exact partition needs:

- Draw the current wall locations. Indicate them using a thick line or a double line.
- Note the toilet centerline locations inside the partition.
- Draw the current partitions, doors and pilasters. Remember to show the door swing (left or right, in or out).
- Indicate all headrail locations, and where they are supported to the wall.

Second Step:

Measure all parts, indicating width and height.

1. Start with measuring distance from building sidewall to centerline of first parallel wall panel. For consecutive partitions, measure centerline to centerline of parallel wall panels.
2. Measure depth of partition—from building back wall to centerline of front pilaster or door.
3. Width of door opening—pilaster to pilaster.
4. Width of each pilaster.

*For all ADA-wheelchair accessible partitions:

- Partition width must be 60" minimum
- Partition depth must be 56" minimum with wall-mounted toilets; 59" minimum for floor-mounted toilets.
- The toilet must be offset on the back wall with its centerline 18" from the nearest building sidewall, or partition wall panel.
- Horizontal grab bars must be mounted behind the toilet and on the nearest building side wall, or partition wall panel (36" and 48" stainless steel grab bars provided by InPro)

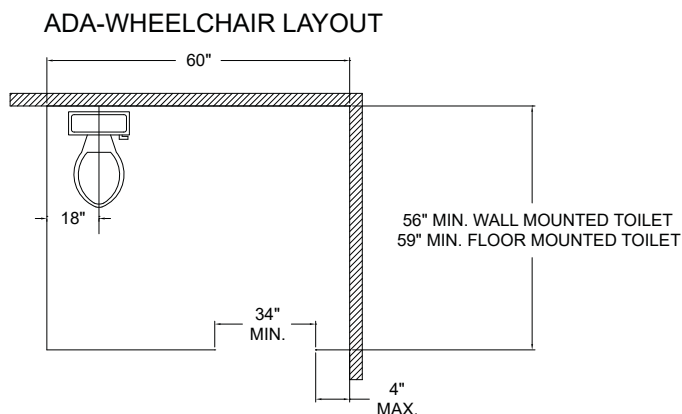

For detailed requirements regarding ADA compliance, see section 604, Water Closets & Toilet Compartments, in the U.S. Department of Justice, 2010 ADA Standards

Floor-to-Ceiling Measurements:

- Floor-to-ceiling measurement MUST be coordinated with the Architect or Structural Engineer to determine the method of mounting the ceiling brackets to the building structure.
- Once ceiling mounting methods have been determined, measure the distance from the finished floor to ceiling mounting.
- Subtract 1-1/2" from this measurement to determine the height of the pilasters (the 1-1/2" deduction is to allow sufficient space for the pilaster floor bracket and ceiling bracket)

* Where ceiling mount is required, structure in ceiling is not furnished by inpro®. Actual mounting system, including lateral bracing if required, must be designed by the Architect or Structural Engineer and furnished by others.

Prism™ Solid Surface Privacy Partitions

Measuring Guide

Recessed Layout

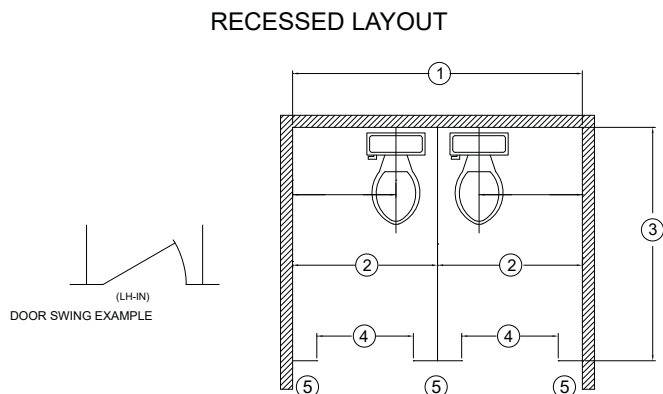

First Step:

Simple drawings are often the best way to provide information to InPro. Follow these simple steps to determine your exact partition needs:

- Draw the current wall locations. Indicate them using a thick line or a double line.
- Note the toilet centerline locations inside the partition.
- Draw the current partitions, doors and pilasters. Remember to show the door swing (left or right, in or out).
- Indicate all headrail locations, and where they are supported to the wall.

Second Step:

Measure all parts, indicating width and height.

- 1 Start with measuring distance from building sidewall to sidewall
- 2 For consecutive partitions, measure centerline to centerline of parallel wall panels.
- 3 Measure depth of partition—from building back wall to centerline of front pilaster or door.
- 4 Width of door opening—pilaster to pilaster.
- 5 Width of each pilaster.

*For all ADA-wheelchair accessible partitions:

- Partition width must be 60" minimum
- Partition depth must be 56" minimum with wall-mounted toilets; 59" minimum for floor-mounted toilets.
- The toilet must be offset on the back wall with its centerline 18" from the nearest building sidewall, or partition wall panel.
- Horizontal grab bars must be mounted behind the toilet and on the nearest building side wall, or partition wall panel (36" and 48" stainless steel grab bars provided by InPro).

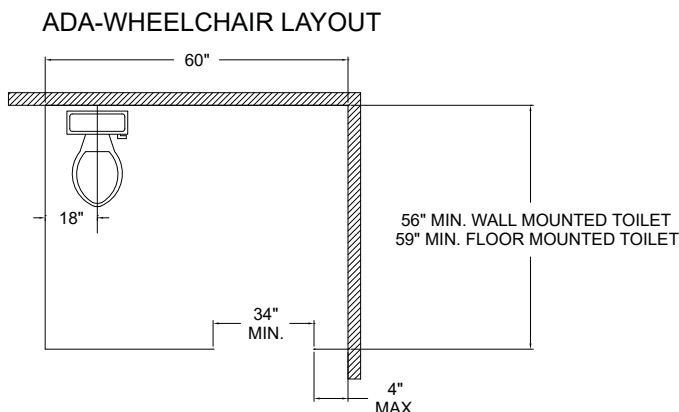

For detailed requirements regarding ADA compliance, see section 604, Water Closets & Toilet Compartments, in the U.S. Department of Justice, 2010 ADA Standards

Prism™ Solid Surface Privacy Partitions

Measuring Guide

Alcove Layout

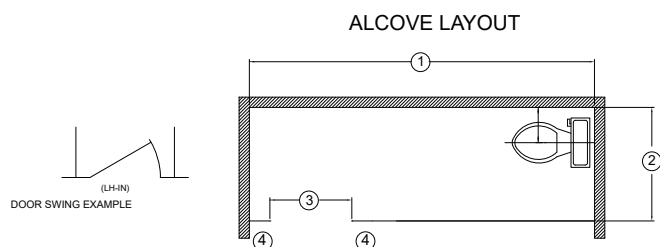

First Step:

Simple drawings are often the best way to provide information to InPro. Follow these simple steps to determine your exact partition needs:

- Draw the current wall locations. Indicate them using a thick line or a double line.
- Note the toilet centerline locations inside the partition.
- Draw the current partitions, doors and pilasters. Remember to show the door swing (left or right, in or out).
- Indicate all headrail locations, and where they are supported to the wall.

Second Step:

Measure all parts, indicating width and height.

- 1 Start with measuring distance from building sidewall to centerline of first parallel wall panel. For consecutive partitions, measure centerline to centerline of parallel wall panels.
- 2 Measure depth of partition—from building back wall to centerline of front pilaster or door.
- 3 Width of door opening—pilaster to pilaster.
- 4 Width of each pilaster, wall panel.

*For all ADA-wheelchair accessible partitions:

- Partition width must be 60" minimum
- Partition depth must be 56" minimum with wall-mounted toilets; 59" minimum for floor-mounted toilets.
- The toilet must be offset on the back wall with its centerline 18" from the nearest building sidewall, or partition wall panel.
- Horizontal grab bars must be mounted behind the toilet and on the nearest building side wall, or partition wall panel (36" and 48" stainless steel grab bars provided by InPro).

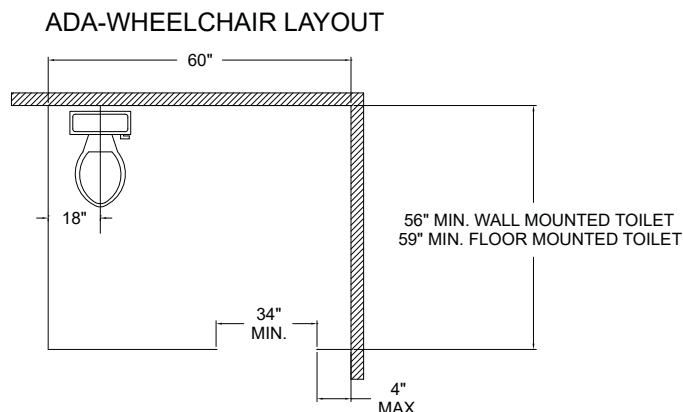

For detailed requirements regarding ADA compliance, see section 604, Water Closets & Toilet Compartments, in the U.S. Department of Justice, 2010 ADA Standards

Prism™ Solid Surface Privacy Partitions

Measuring Guide

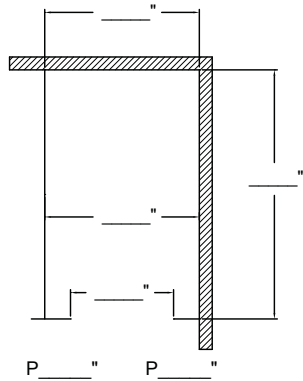

- RIGHT WALL LAYOUT**
1. Indicate toilet locations
 2. Draw doors signifying swing (see example)
 3. Fill in dimensions and pilaster widths, at the P ___\"
 4. Place an "X" on the partition walls to specify headrail locations

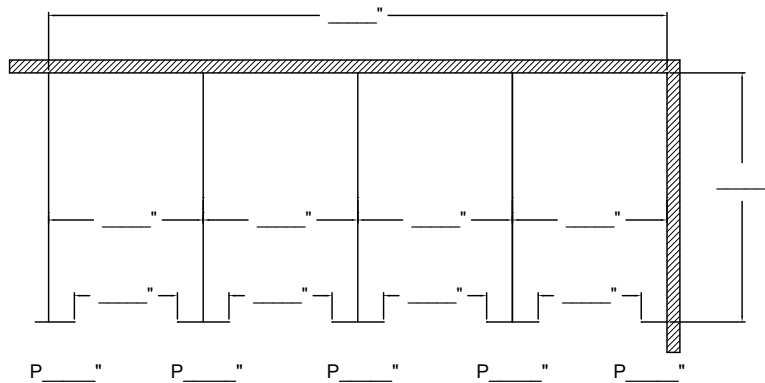
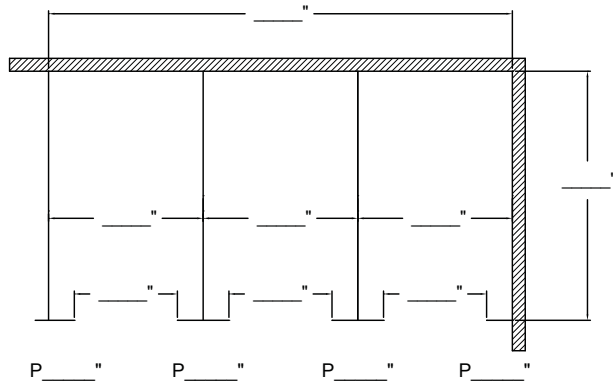
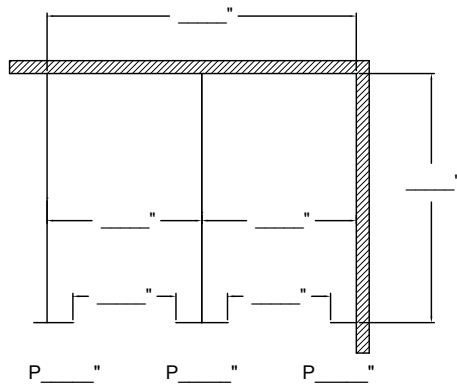
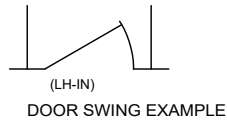

For detailed requirements regarding ADA compliance, see section 604, Water Closets & Toilet Compartments, in the U.S. Department of Justice, 2010 ADA Standards

Prism™ Solid Surface Privacy Partitions

Measuring Guide

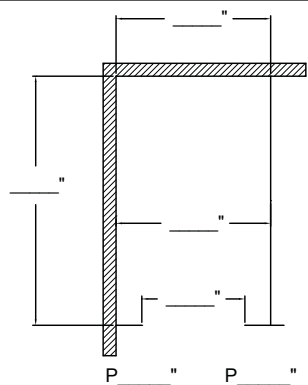

- LEFT WALL LAYOUT
1. Indicate toilet locations
 2. Draw doors signifying swing (see example)
 3. Fill in dimensions and pilaster widths, at the P ___"
 4. Place an "X" on the partition walls to specify headrail locations

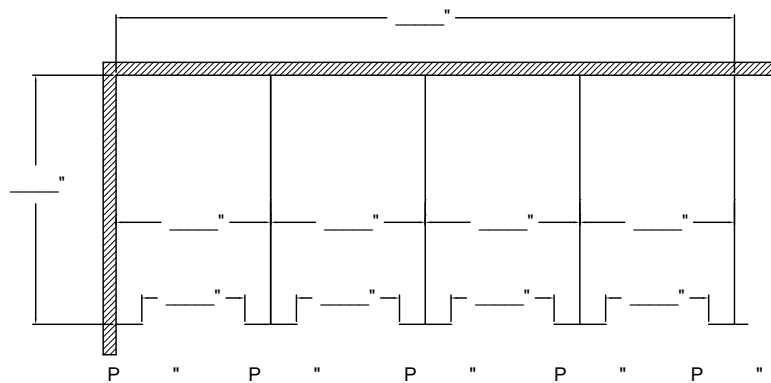
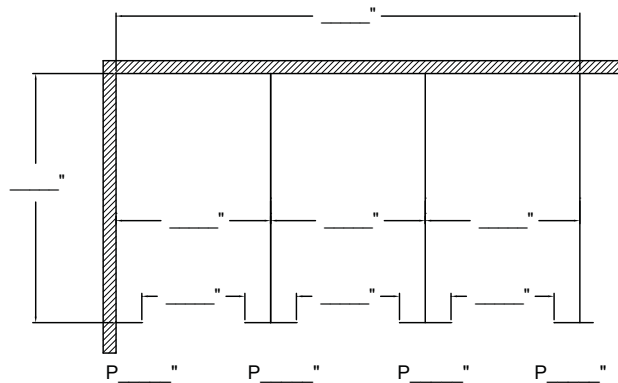
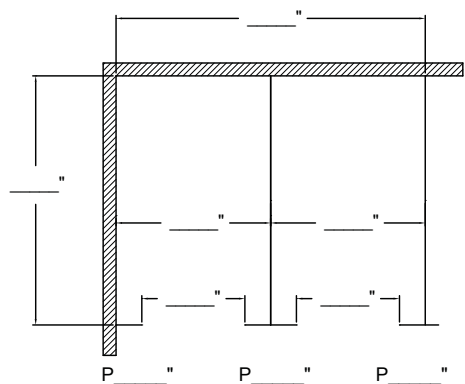
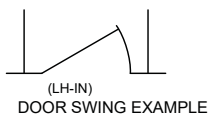

*For detailed requirements regarding
ADA compliance, see section 604,
Water Closets & Toilet Compartments,
in the U.S. Department of Justice,
2010 ADA Standards*

Prism™ Solid Surface Privacy Partitions

Measuring Guide

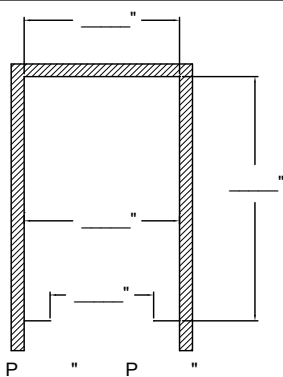

- RECESSED LAYOUT
1. Indicate toilet locations
 2. Draw doors signifying swing (see example)
 3. Fill in dimensions and pilaster widths, at the P ___\"
 4. Place an "X" on the partition walls to specify headrail locations

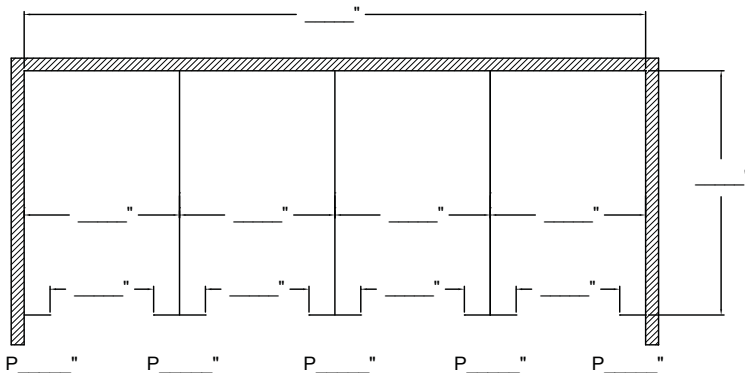
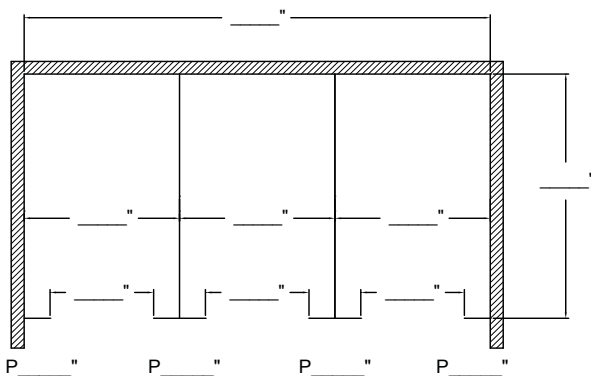
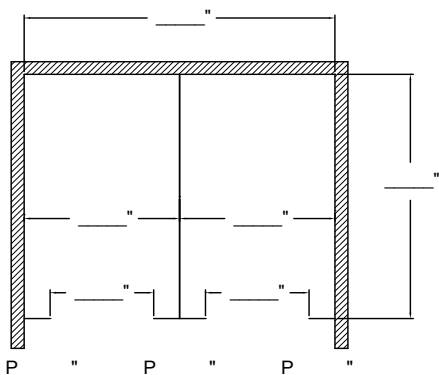
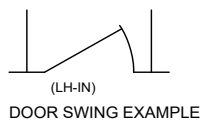

For detailed requirements regarding
ADA compliance, see section 604,
Water Closets & Toilet Compartments,
in the U.S. Department of Justice,
2010 ADA Standards

Prism™ Solid Surface Privacy Partitions

Measuring Guide

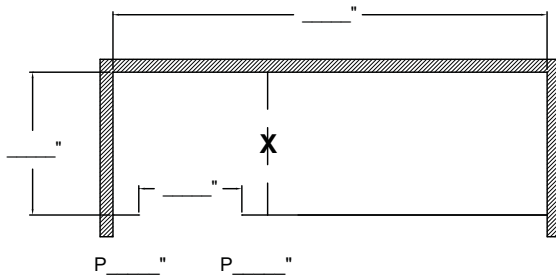

- ALCOVE LAYOUT**
1. Indicate toilet locations
 2. Draw doors signifying swing (see example)
 3. Fill in dimensions and pilaster widths, at the P _____ "
 4. Place an "X" on the partition walls to specify headrail locations

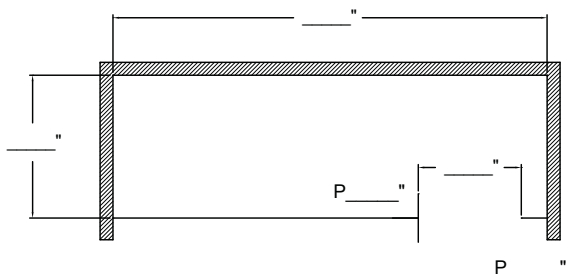
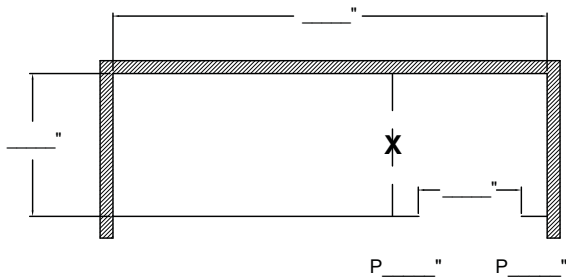
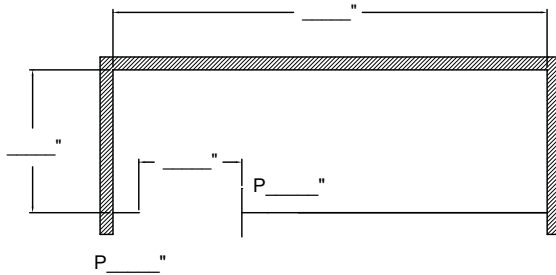
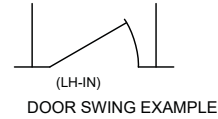

*For detailed requirements regarding
ADA compliance, see section 604,
Water Closets & Toilet Compartments,
in the U.S. Department of Justice,
2010 ADA Standards*

Prism™ Solid Surface Privacy Partitions

Measuring Guide

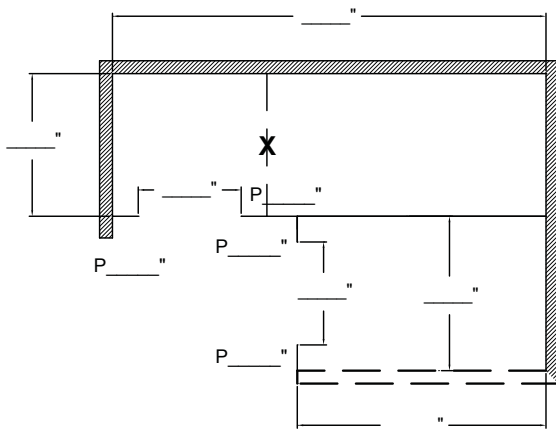

- VARIABLE LAYOUT
1. Indicate toilet locations
 2. Draw doors signifying swing (see example)
 3. Fill in dimensions and pilaster widths, at the P ____"
 4. Place an "X" on the partition walls to specify headrail locations

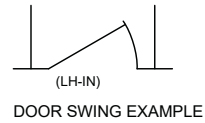

WALL or PARTITION PANEL
(please circle one)

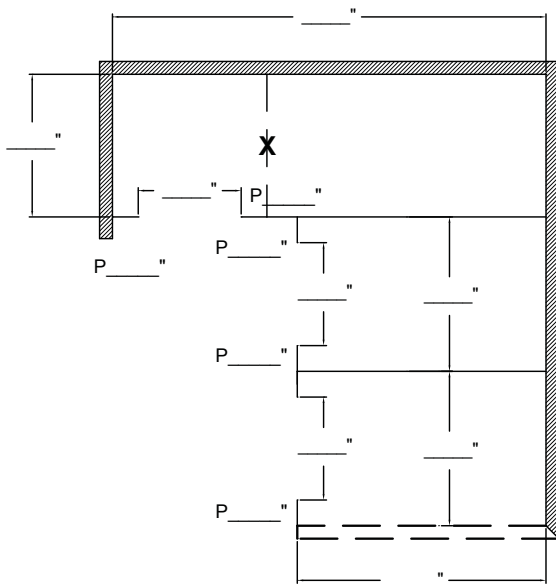

WALL or PARTITION PANEL
(please circle one)

*For detailed requirements regarding
ADA compliance, see section 604,
Water Closets & Toilet Compartments,
in the U.S. Department of Justice,
2010 ADA Standards*

Prism™ Solid Surface Privacy Partitions

Measuring Guide

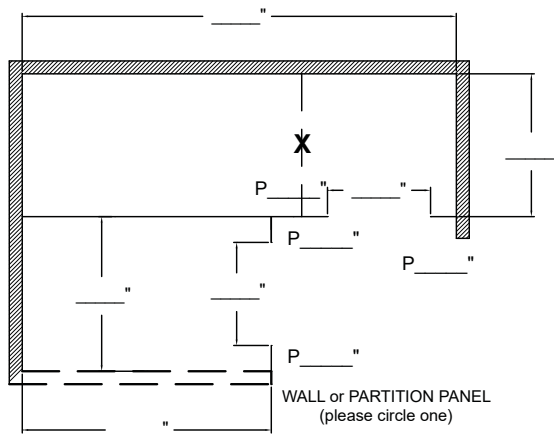

- VARIABLE LAYOUT
1. Indicate toilet locations
 2. Draw doors signifying swing (see example)
 3. Fill in dimensions and pilaster widths, at the P ____ "
 4. Place an "X" on the partition walls to specify headrail locations

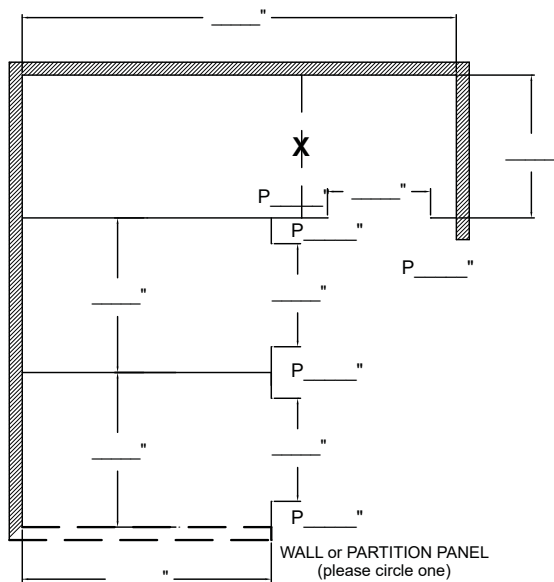
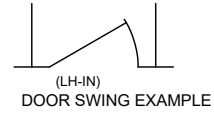

For detailed requirements regarding ADA compliance, see section 604, Water Closets & Toilet Compartments, in the U.S. Department of Justice, 2010 ADA Standards

Prism™ Solid Surface Privacy Partitions

Measuring Guide

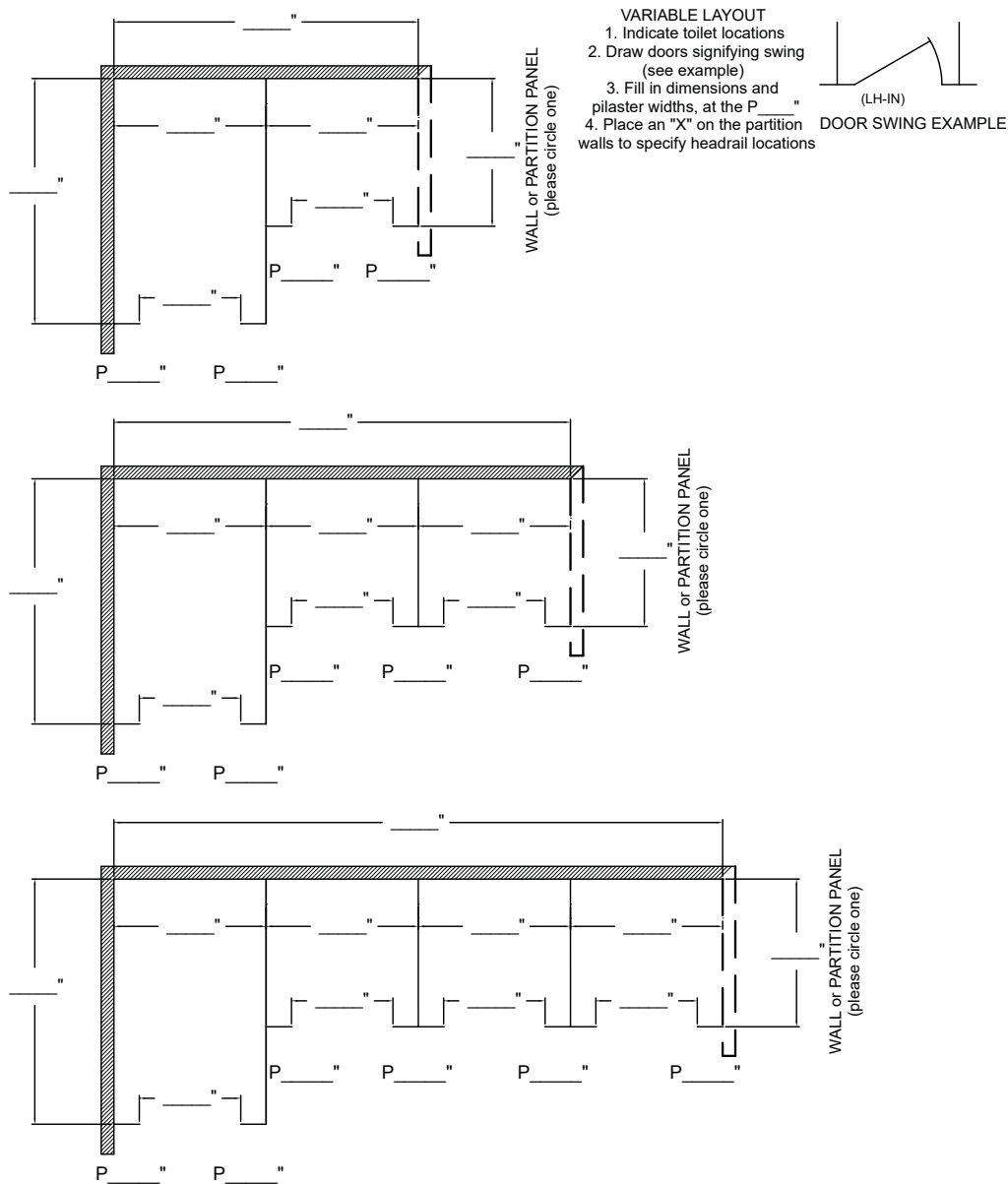

For detailed requirements regarding ADA compliance, see section 604, Water Closets & Toilet Compartments, in the U.S. Department of Justice, 2010 ADA Standards

Prism™ Solid Surface Privacy Partitions

Measuring Guide

WALL or PARTITION PANEL
(please circle one)

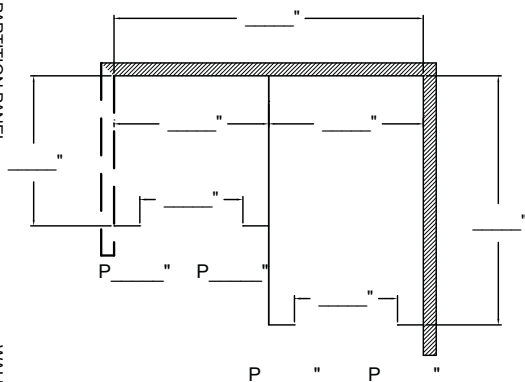

- VARIABLE LAYOUT
1. Indicate toilet locations
 2. Draw doors signifying swing (see example)
 3. Fill in dimensions and pilaster widths, at the P _____
 4. Place an "X" on the partition walls to specify headrail locations

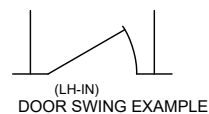

WALL or PARTITION PANEL
(please circle one)

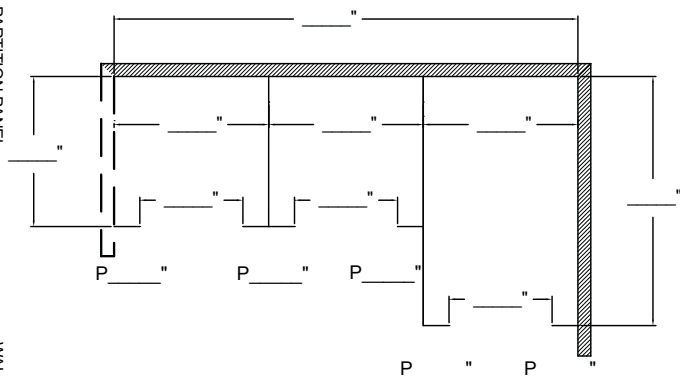

WALL or PARTITION PANEL
(please circle one)

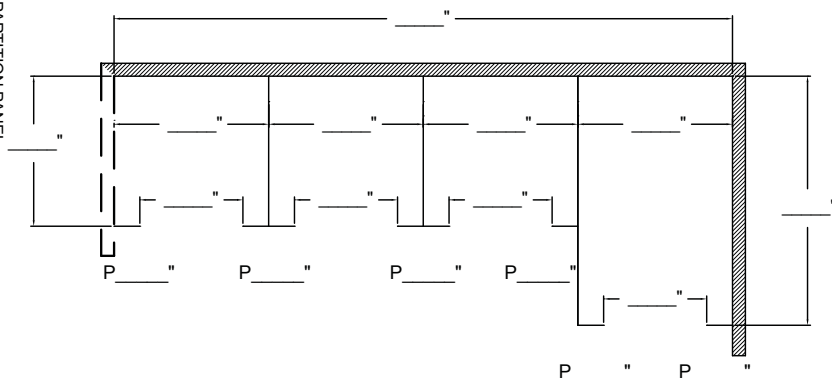

For detailed requirements regarding
ADA compliance, see section 604,
Water Closets & Toilet Compartments,
in the U.S. Department of Justice,
2010 ADA Standards